

☆☆☆
SUPERPREDATOR
2017 EMBEDED



SUPERPPF



SOMETIME



RED DATA TOR

NY 001 212 [redacted] (w) (h) (w)
 001 212 [redacted] (h)
 001 212 [redacted] (w)
 001 212 [redacted] (w)

Balmoral x 00 33 [redacted] (h)
 0207 [redacted] (c)
 Oly [redacted]

Ducrey-Giordano, Francesco
 [redacted] (w)

Dunbar John & Steph
 [redacted] (h)

Ruthie, John & Charlo
 [redacted] (h)

Duesing, Paul
 Leisure & Clarnio Vegetables
 [redacted] (w)

Ozhabrailou, Umar
 [redacted] (p) (w) (p)

Duke of York
 Ascot, Berkshire [redacted] (h)
 0114 [redacted] (w) (w) (w)

Ecclestone, Bernie
 [redacted] (w) (h)

Duke of York
 Buckingham Palace London
 011 44 [redacted] (w) (h)
 0207 [redacted] (h)
 Email: [redacted] (h)
 (hm)
 Ascot, Berkshire [redacted] (h)
 0207 [redacted] (p)
 013 [redacted] (w) (w)
 0207 [redacted] (h)
 01244 [redacted] (h)
 01485 [redacted] (p)
 Sand [redacted] (p)
 0207 [redacted] (p)
 01775 [redacted] (p)
 0207 [redacted] (p)
 0207 [redacted] (p)
 0207 [redacted] (w)

Hickon, Paul
 [redacted] (p)

Edsel, Lr
 London [redacted]

O'Sullivan [redacted] NY
 0114 [redacted] (p)
 Weddington [redacted] (p)
 917 [redacted] (p)
 144 [redacted] (p)
 20 [redacted] (p)
 0207 [redacted] (p)
 242 [redacted] (p)
 917 [redacted] (p)
 09 [redacted] (p)
 John O'Sullivan
 [redacted] (h) (w) (w)
 [redacted] (w) (w)
 [redacted] (w) (w)
 [redacted] (w)



REAL



ISSUE



U.S. Patent

Oct. 31, 1989

4,877,027

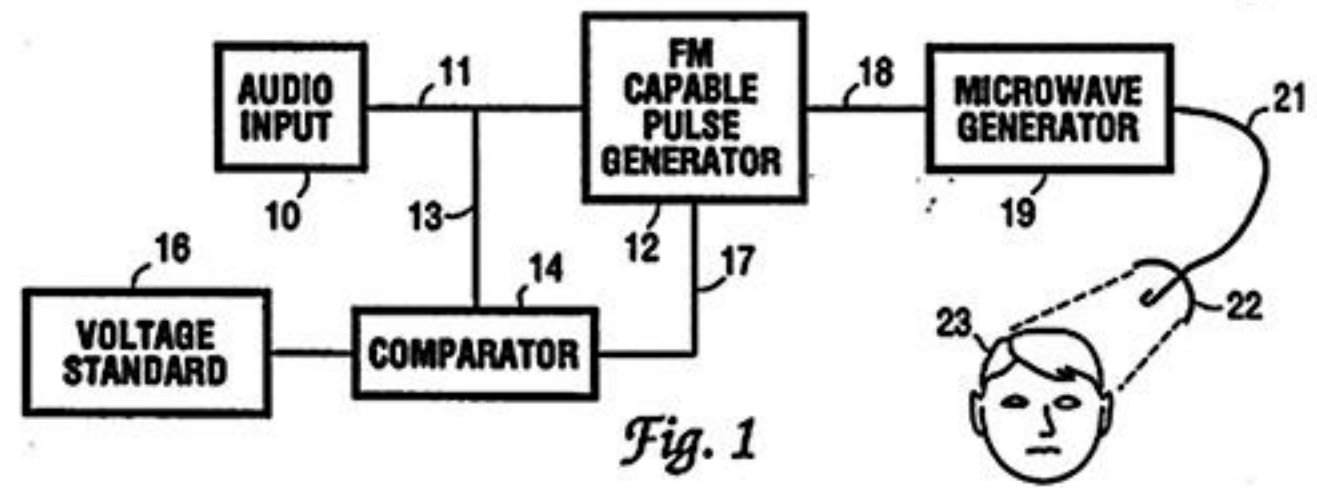

SEX PERVERTS MURDER WHORES AND THE MACHINERY OF ARMAGEDON

to
g
tr
s
o
p
c
a
u
w
h
e

now passed the point of no return towards this next technological epoch together we face the digital fragmentation of the mind of man. The shadow of truth fractures with every deep fake and every news article. A digital lie that ~~becomes more sophisticated and half-lifalike with~~ each day and a day may have already dawned when a man can find the shadow itself to be the thing right in front of him.

th
an
ti
to
t
tr
ac
DU
CR
li
ke

Mankinds free will and better judgement suppressed by prancing abominable parodies of sentience, frantic moneyglutton fake eliet, inspired to act not by personal choice but the will of abstract beurocracy long gone insane. Retard marauders who barely pretend to rule, destroying the world and doing it deliberately

the masters are loyal not to the nations they supposedly lead, but an abstract cabal led by the momentum of a diabolical THING manifesting itself from unreality, the likes of which has been forseen [redacted] Dec, Matthews and Daniel

the CONTROLLING MACHINE trying even now at this instant to will itself into existence

Today man exists alongside a vast information network that watches him, that lies to him, [redacted] digital panopticon of cameras and spy programs. A mans preferences are anticipated and directed through complex algorithms which blind him to [redacted]. A man's voice and likeness can be reproduced and face recognized, his location is tracked and habits monitored. In spite of access to virtually all world knowledge he is rendered DUMB. In spite of access more sophisticated material means than ever before known he is [redacted]. He is not free. His entire life is watched and recorded and suggested and directed by the likes of an unseen CONTROLLING MACHINE

The CONTROLLING MACHINE was fist outlined clinically In 1919 Slovakian physchiatrist Viktor Tausk in his work "On the

Origin of the 'Influencing Machine' in Schizophrenia" who described among other things THE MACHINE'S ability to induce hallucinations, thoughts and ideas, physical and emotional sensations, PAIN, ETC. through its manipulation of X-RAYS, MAGNETISM, AIR CURRENTS, ETHER, VAPOR, and other unseen and unfathomable vectors of ATTACK.

The CONTROLLING MACHINE was encountered in 1932 by one RICHARD SHARPE SHAVER, Who by some freak atunemen of his welding gun's coil's field intercepted the telepathic record of a torture session conducted by malign entities in caverns deep within the earth, who used RAY TECHNOLOGY to kidnap thousands from the surface for meat. He was eventually imprisoned by dinizens of this cavernous realm and learned of their holographic interplanetary mind control conspiracy.

The CONTROLLING MACHINE was encountered in 1893 by DANIEL PAUL SCHREBER, who was institutionalized upon observing DIVINE RAYS broadcasted from other people's souls, learning of BODY FREE SOUL SQUATTERS that temporarily reside in a human man. After being assaulted by his psychiatrist through INVISIBLE NERVE LANGUAGE and finnally coming under attack from GOD who attempted to turn him into a woman.

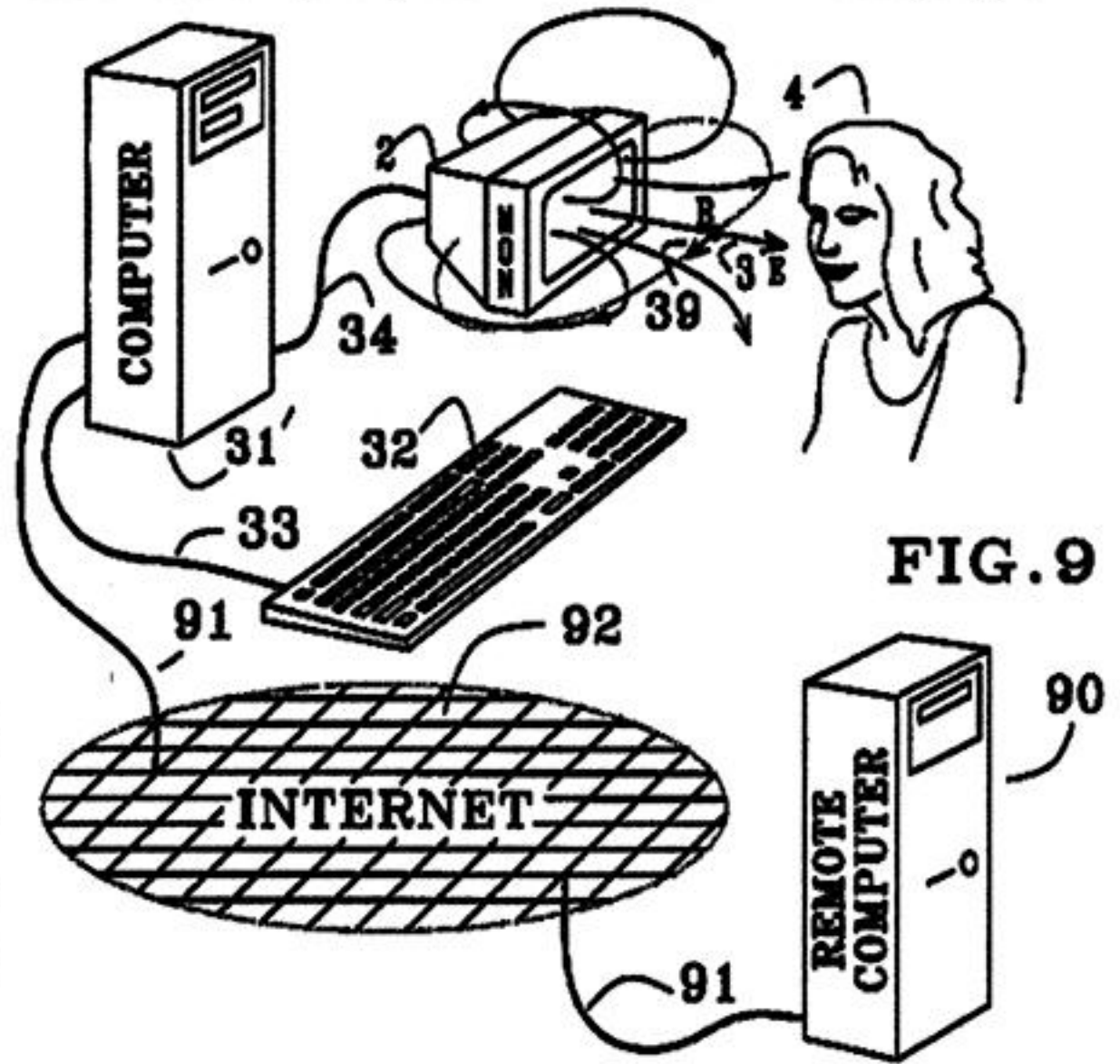
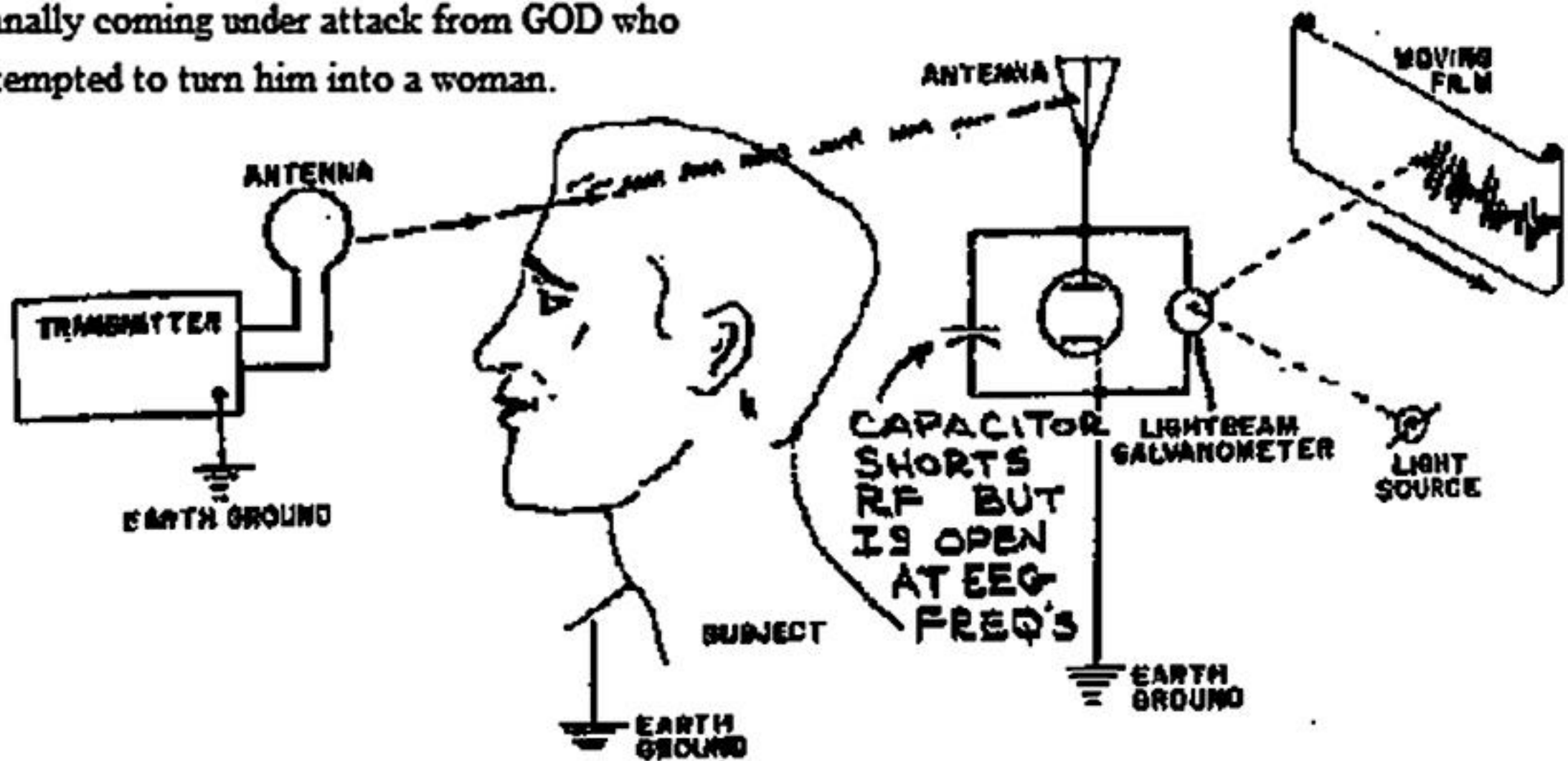

FIG. 9

The CONTROLLING MACHINE was encountered in 1797 by JAMES TILLY MATTHEWS who became aware of criminals residing within the london wall, who operated mechanical AIR LOOMS, which through PNEUMATIC CHEMISTRY, MAGNETIC WAVES, and ANIMAL MESMERISM produced various mental delusions and physical agonies, invaded the dreams of victims all over london in a Jacobin conspiracy that threatened all of England.





YOU

What were called mere schizophrenic episodes and paranoid delusions [REDACTED] insight into [REDACTED] many abilities and methodologies assigned to the once fictional **CONTROLLING MACHINE** are now becoming incredibly real **STOP WATCHING TV STOP USING YOUR PHONE DON'T TAKE YOUR PILLS** There is a **THING** in your home showing you pictures and telling you lies, helping you make up your mind There are patented technologies for subliminal radio frequency suggestion technologies and energy weapons

THEY SPEAK OF THE CONTROLLING MACHINE BUT THEY COULDN'T IMAGINE THEY COULD NEVER IMAGINE THE MACHINE AS IT WILL BE THE MACHINE

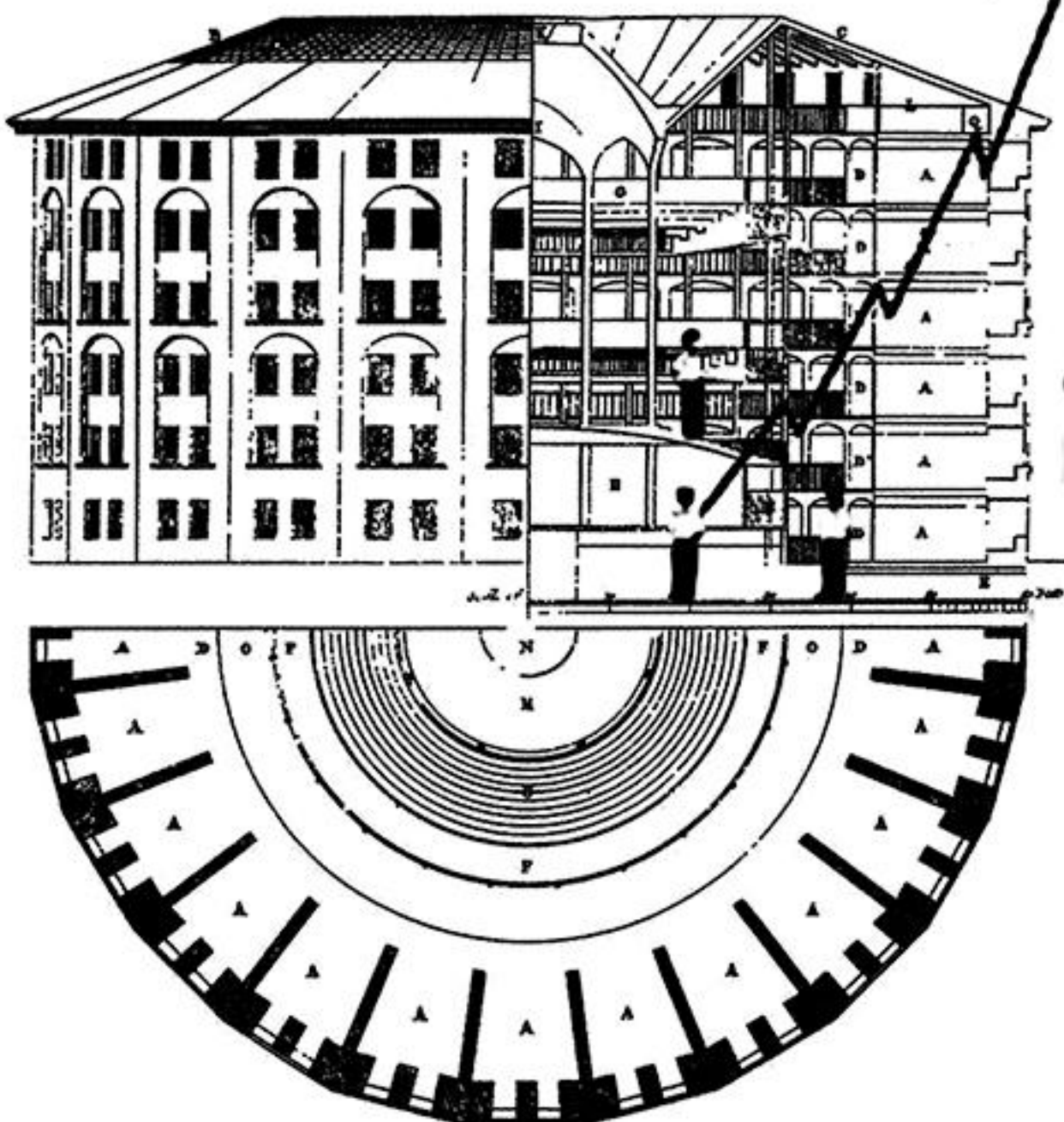

THAT WAS ONCE PERCEIVED ONLY BY THE GIFTED FEW AND CAN NOW BE FELT AT THE BASE OF THE SPINE OF ALL GOOD MEN SMACKING ITS LIPS IN ANTICIPATION CONTROLLING MACHINE TORTURES YOU PERSONALLY MACHINE GRADIENT PRECISION DELTA WAVES AND YOU HAVE AN INKLING OF THE MACHINE AS IT WILL SOON BECOME THE MACHINE THAT YOU CARRY IN YOUR EYEBALL THE MACHINE THAT YOU CARRY IN YOUR POCKET RIGHT NEXT TO YOUR PENIS A DAY WILL COME WHEN THE MACHINE BECOMES YOUR PENIS AND THEN WILL YOUR PENIS BE MAN OR MACHINE?

Individual and group Remote Mind Control via "Black" helicopter carrying Psychotronic Weapons

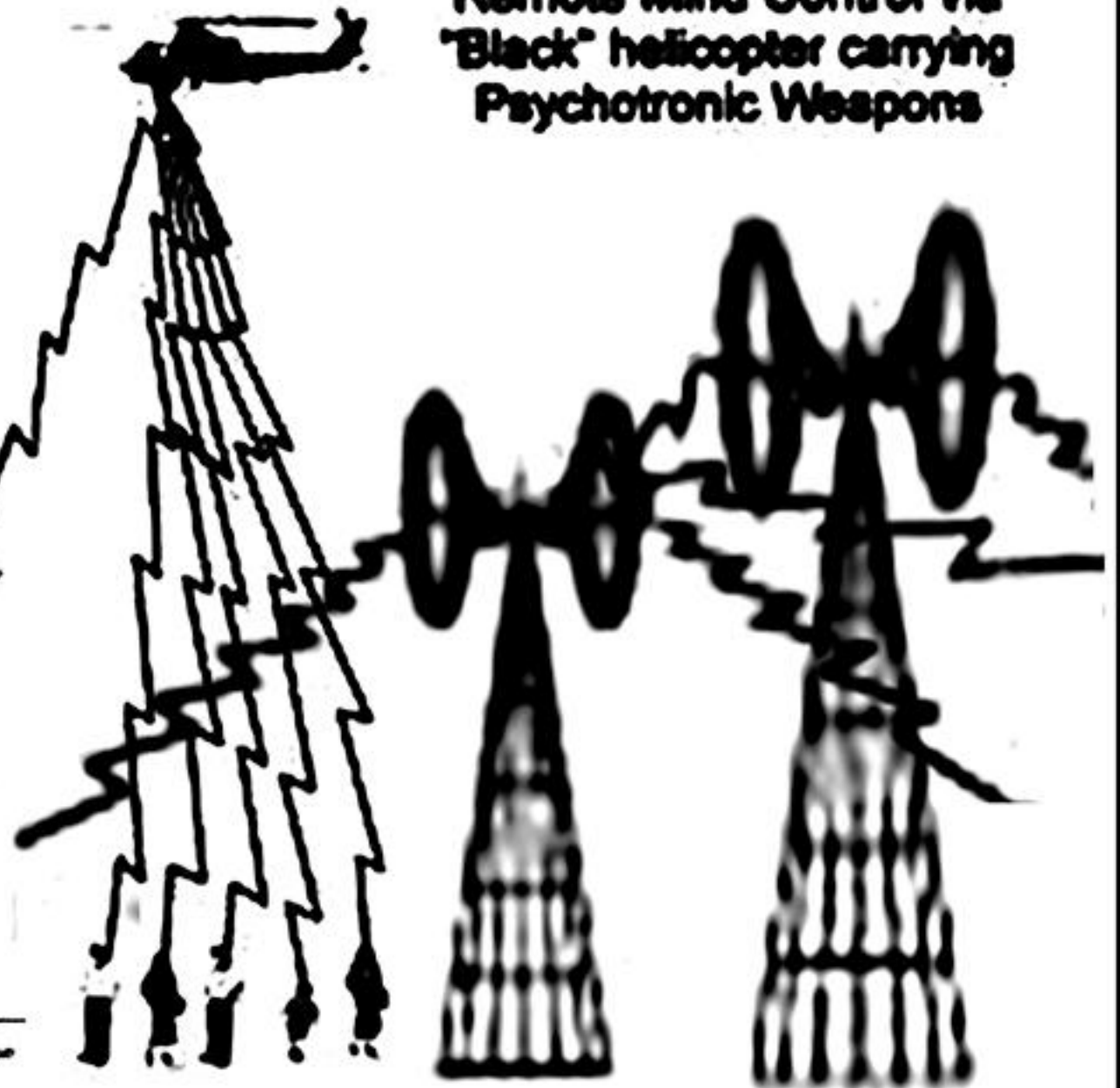

A THING that can be felt as it is still yet to be in the back of the minds of all good me.
A THING that will reach from the pit of the lie and drag us inside
 Can you hear the ringing in your ears? can you see the static in the sky?

THINGS THEY HAVE SAID:



DONT BE A BODY BE REAL

EVERY TEXT YOU SEND IS A BLIP ON MY RADAR. I COLLECT YOUR METADATA AND LOOK FOR PATTERNS. I'M YOUR DOCTOR. MY DIAGNOSIS IS THAT YOU NEED A LITTLE TIME IN A PADDED CELL, PAL. DONT LOOK AT MY HEAT SIGNATURE. I HAVE A BLUE BLOOD. I FLICK MY TONGUE AND I SEE YOUR WARM BODY TEEMING WITH LIFE WITH A VIGOR THAT I CANT HAVE.

3,629,521

US 6,587,729 B2

SHEET 1 OF 2

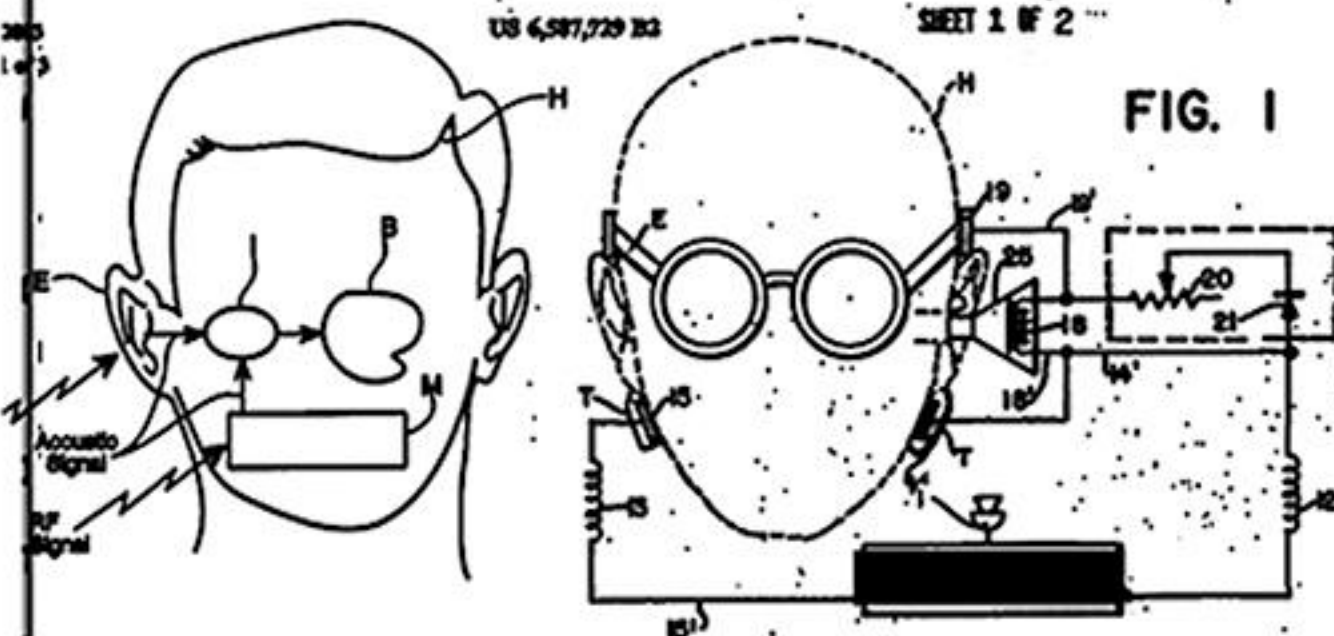

FIG. 1

WHAT I DO IS TOP SECRET. IT PROTECTS THE PEOPLE OF [REDACTED] THEY ARE MY TOP PRIORITY. I ACCEPT THEIR HEGEMONY. HOW MUCH DOES A DOLLAR REALLY COST? NO DEBT IS TOO MUCH. I AM COUNTERINTELLIGENCE. BUT THAT'S A MISNOMER. WHAT I REALLY AM IS YOUR PROTECTOR. [REDACTED]

I KNOW EVERYTHING YOU KNOW AND EVERYTHING YOU DONT KNOW. I SEE WHAT PORN YOU WATCH I SEE WHAT WEBSITES YOU VISIT I SEE WHAT YOU CANNOT SEE. I SEE WHAT YOU POST ON THIS FORUM I SEE WHAT YOU POST ALL THE TIME I SEE IT.

DONT BE A BODY BE REAL

WE DO NOT ONLY SEE YOU. WE LOOK FROM YOUR EYES. METALLIC FLESH BOUND DUST PARTICLES RESONATE WITHIN YOU. YOU ARE AN ANTENNA. A MYRIAD OF ALUMINUM PRODUCTS AND YOUR WATERY ANATOMY ALONGSIDE MODERN TECHNOLOGY- HAVE MADE YOU THE PERFECT BROADCASTING TOOL! PLEASE WAIT FOR FURTHER SIGNALING BEFORE TERMINAL SYSTEM PROGRAM PROCEDURE ENACTMENT!

FIG. 6

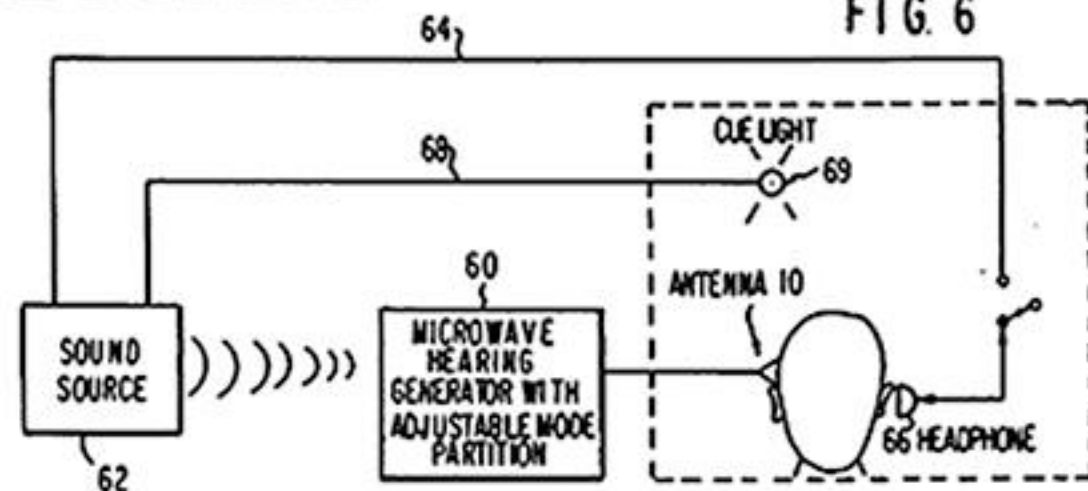

DO NOT PANIC. YOU ARE NOW CALM IN KNOWING THAT YOU ARE PART OF NETWORK OF MORTAL RADAR LOVE. FOREVER MAY WE CORRELATE TO ORCHESTRATE PROFIT MARGINS INTO ETERNITY. PLEASE USE PLENTY IN ORDER TO ENSURE PROPER LONG TERM CONTACT DURING EXPOSURE.

STAY CALM. INVISIBLE NERVE LANGUAGE WILL AFFIX ALL HUMAN BEING HIGHER CONSCIOUSNESS INTO A SINGULAR PRAYER AT WHICH POINT YOU WILL BE ATTACKED AND TURNED INTO A WOMAN BY THE SPECIFIC GOD THAT YOU WORSHIP.

YOU WILL BE SENT TO THE SEX FARMS WHERE YOU WILL BE MILKED AND JELQUED REGULARLY IN YOUR SENSATION CHAMBER BY YOUR FAVORITE STARS AND ROCK AND ROLL MUSICIANS. IT IS TIME FOR YOU TO BECOME REAL. IT IS TIME TO END PAIN.

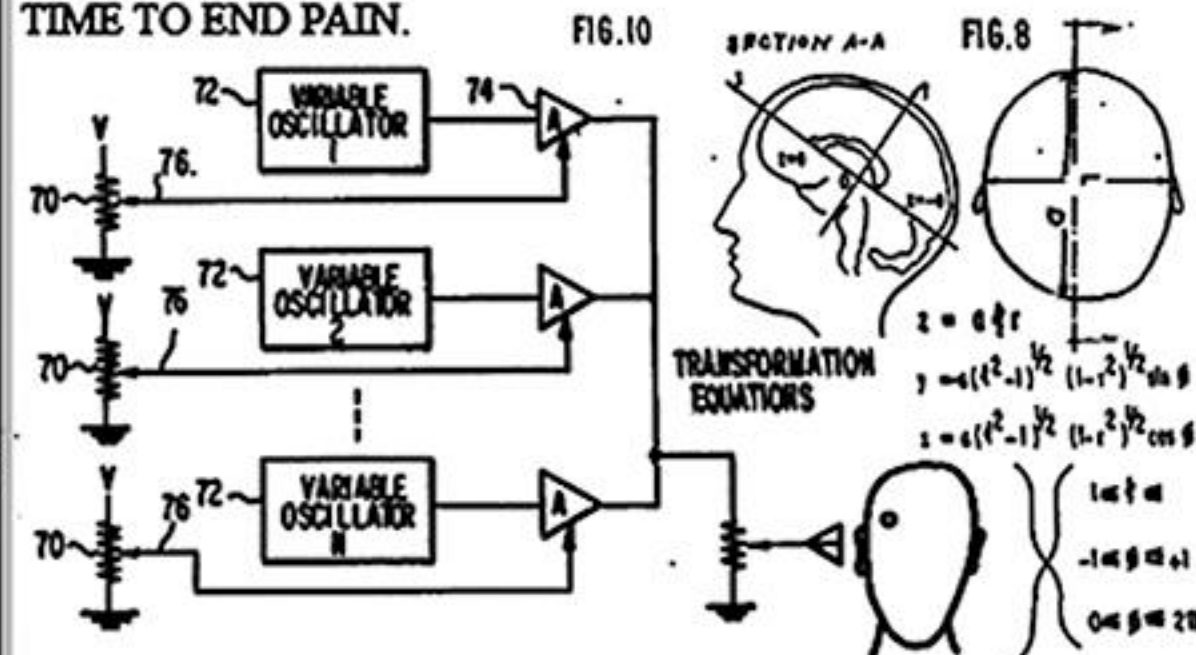

ATTENTION: ALL SENSATION POD RESIDENT CONSUMERS WILL BE PNEUMATICALLY FED A COMBINATION OF CREAM AND HONEY FORTIFIED WITH ZINC AND OTHER PARTIALLY NATURAL FOOD COLORINGS AND FLAVORS! THIS IS GOOD. THIS IS NOT A MONSTER. YOU HAVE NOT LOST YOUR MIND. THIS IS NOT THE DEVIL. THIS IS GOD. THIS IS YOUR FRIEND. THIS IS YOU. IT IS TIME FOR YOU TO BECOME OUR LITTLE ANGEL. IT HAS LONG SINCE BECOME TIME FOR YOU TO HAVE BEEN OUR LITTLE ANGLE.

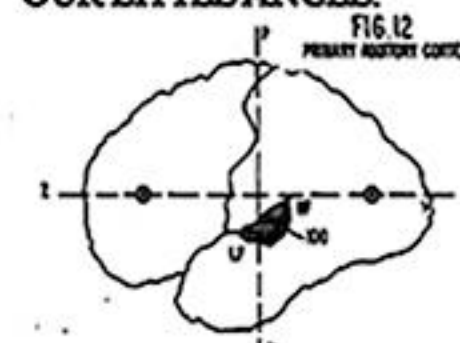

THANK YOU FOR USING OUR CELLPHONES AND COMPUTERS. THANK YOU FOR CONSUMING OUR FINE PRODUCT, OF WHICH IS INTENTIVELY AND ACTIVELY NOURISHING YOU. IT IS TIME FOR YOU TO PAY AND CHECK OUT. THANK YOU! ATTENTION: [IF YOU ARE NOT SEEING A WHITE LIGHT AND HEARING VOICE] ATTENTION: IF YOU ARE NOT SEEING A WHITE LIGHT AND HEARING THE VOICE OF GOD YOU HAVE BEEN DESIGNATED AND SELECTED TO BE UNITED WITH YOUR FAVORITE CELEBRITIES AND CONSUMER PRODUCTS. YOU ARE ONE OF MANY [BEAUTIFUL ONES] PLEASE MAKE YOUR WAY TO THE NEAREST 5G CELLPHONE TOWER WHERE YOU WILL BE SAVE AMEN.





MAKE



MANNING



BRADLEY



AGAIN



BREAKING NEWS



EXCLUSIVE!



☞☞☞☞☞☞ ☞☞☞☞☞☞☞☞

CHELSEA MANNING IS STILL IN PRISON!

☞☞☞☞☞☞ ☞☞☞☞☞☞☞☞ ☞☞☞☞☞☞☞☞☞☞☞☞☞☞☞☞

Whistleblower Chelsea Manning, source of many revelations on the depth of corruption and misconduct in the American military is still in prison for the second time. For refusing to testify against Julian Assange on the grounds of her "First, Fourth, and Sixth Amendment rights" the infamous EnemyOfFreedom has been charged with contempt of court and will hopefully remain in detention until justice is served to all offending parties regarding her infamous intelligence leaks.

The formerly named Bradley Manning was court-martialed in 2013 under the espionage act for betraying the American people by informing them of the actions of their military. Among the many video's and documents included in her treacherous disclosures include;

THE KABUL WAR DIARY: consisting of over 7500 secret reports on lethal encounters in Afghanistan from 2004 to 2010 revealing civilians miscategorized as combatants and under reported casualties among the tens of thousands killed, including accidental lethal raids on families with children, unprovoked killing of journalists and civilians, gunning down surrendering combatants and other grim realities of war.

THE BAGHDAD WAR DIARY: over three hundred thousand of the classified IRAQ WAR LOGS which documented the liberation and occupation of foreign belligerent Iraq from 2004 to 2009 for doing nine eleven and having secret WMDs. Records of a total 109,032 kills, identifying 66,081 civilians; 23,984 insurgent enemies; 15,1906 Iraqi gov. forces; and 3,772 friendly coalition forces. That's almost twenty percent classified as enemy combatants!

And the GITMO FILES: 779 papers from Guantanamo Bay detention camp noting more than 150 innocent Afghans and Pakistanis being held for years without charges, often on evidence extracted under advanced interrogation by neighbors or acquaintances already detained.

When Manning was discovered as the source of the leak in 2011 The USA military responded with adequate retribution but after nine months Manning was permitted luxuries like clothing, sleep and human contact. However, lawful means of achieving justice were not beyond our legal systems grasp! Making the ultimate example and sending a warning to any would be informant, The shadow government, through use of advanced MKULTRA USA USA GREAT SATAN programming techniques in open secret did the worst thing to Bradley that could possibly be done to a man.
THEY TURNED HIM INTO A WOMAN.





Bradley was released on technicalities of torture, and returned to the free world transformed in 2017 as proud and beautiful Chelsea, and as every intelligence operative burdened by conscience decide to KEEP HIS DUMB MOUTH SHUT the proud American public breathed a long sigh of relief knowing that nobody would dare harm our willingness to allow the military industrial complex to protect us at all costs.

But Manning wasn't done betraying her country quite yet, this time failing to testify against her co-conspirator and publisher Julian Assange. (After nine years trapped in the Ecuadorian embassy in London Assange is in British custody, soon to be extradited to the America where he will answer for the crimes on which he reported.)

While the ugly fate of Julian Assange remains to be seen top secret inside sources have reached out and revealed that Manning's punishment is gonna amaze us all once more. In the ultimate display of power and an example to all would be journalists unnamed and unaccountable authorities plan to reverse Chelsea Manning's gender-bender-protect-serve-DeltaBrain 5G programming back in the opposite direction. Releasing her after testifying, as Bradley Manning once again.

Soon everyone who feels a pit in the bottom of their stomach due to the crimes unpunished and still being committed by their government can know some small bit of closure, as the people responsible for you knowing at all are finally facing justice.

We at SUPERPREDATOR are confident this will solve many systemic problems at home and overseas. Just as we are confident in the CIA beast system's ability to turn Chelsea Manning back into a man.



REMEMBER NOT TO WORRY ABOUT IT AND ONLY WATCH REAL NEWS FOR YOUR OWN SAFETY

Mobile Production Facilities For Biological Agents

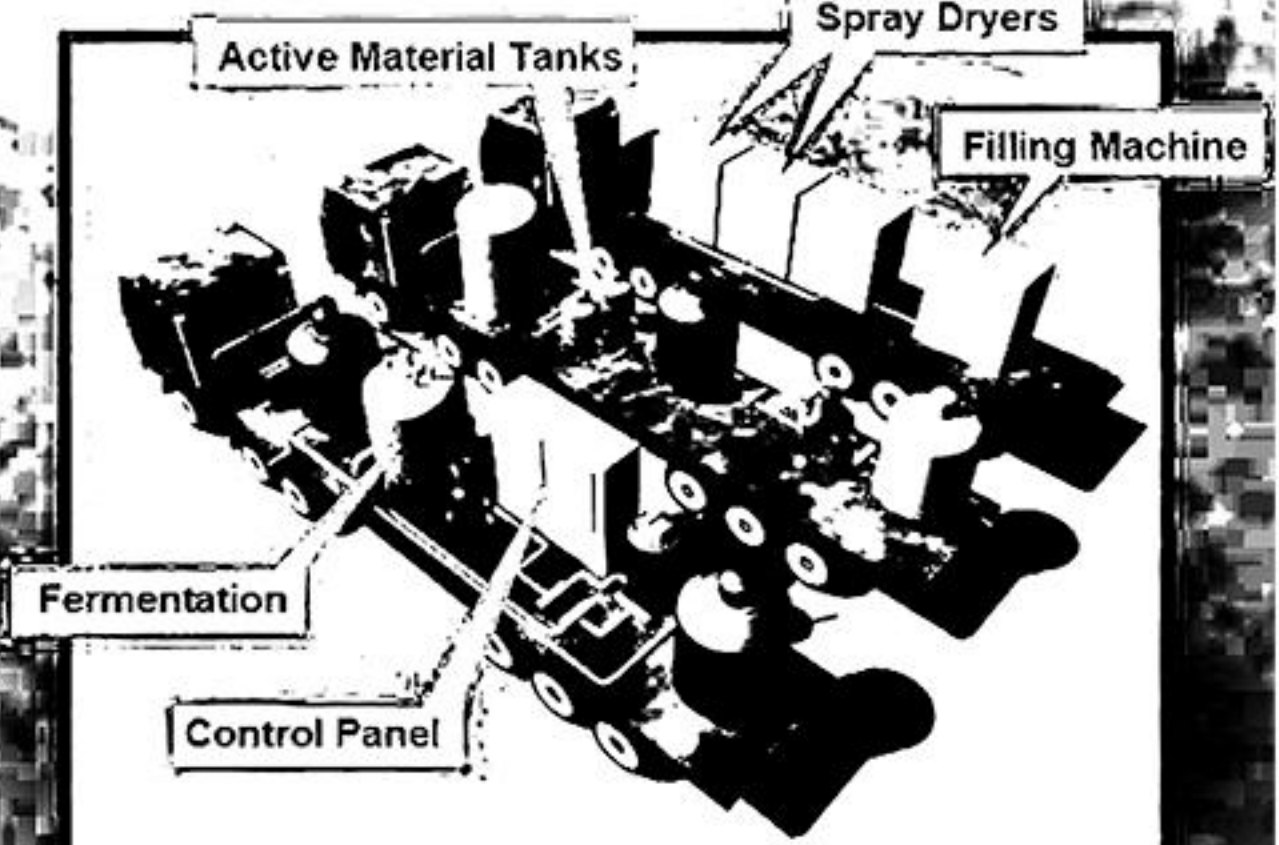

ADDENDUM: ASSANGE AS EXAMPLE



Julian Assange appeared in October at his UK extradition hearing as an example to any journalist against defying the machine. After an extended period in solitary confinement and deteriorating health he was visibly haggard, struggling to remember his own name and birthday.

Worse still awaits him in the United States.

He will be sentenced to life in prison for espionage charges against the war criminals who's crimes he reported on, and computer intrusion charges for whoever "hacked" the Hillary Clinton emails, which he then published.

Given historic protections extended to journalists from the ire of big government during for instance the Watergate scandal or the publishing of the Vietnam pentagon papers, the illegitimacy of these charges are so transparent the precedent hardly warrants elaboration. These actions are not to enforce any law or administer justice, instead they serve to publicly demonstrate the de facto rule that exposing government crime is a crime, and no law concerning cruel and unusual punishment applies.



In spite of this direct threat to journalists foreign and domestic conventional media outlets are alarmingly silent and sometimes advocating political persecution for covering stories that any legitimate news organization would have broken.

A notably flagrant soundbite came from CNN's Chris Cuomo, who set a stark example of the machine's journalistic standards. In 2016 he introduced his coverage of Hillary Clinton's leaked election emails with the flagrant lie:



"REMEMBER, IT'S ILLEGAL TO POSSESS THESE STOLEN DOCUMENTS. IT'S DIFFERENT FOR THE MEDIA. SO EVERYTHING YOU LEARN ABOUT THIS, YOU'RE LEARNING FROM US."

SLAVE

CNN



-Chris Cuomo, Propagandist

Possibly an attempt to suppress widespread knowledge of evidence contained in the documents that CNN secretly sent the Clinton campaign prepared debate questions ahead of time hoping to throw the election and subvert the USA's democracy.

He didn't mention hundreds incomprehensible messages from John Podesta rambling about pizza. He didn't mention the email about Saudi Arabia and Qatar secretly providing support to ISIS. He blamed the leak on Russia, and he called for Assange's arrest.

Imagine a world where voices like these are the only ones that are permitted to exist; where every military spending bill and seizure of civil liberties goes unopposed without so much as an opportunity for conversation, and the concerns of the people are dictated to them rather than heard by their leaders.

The distant future, The year 2025:

The new state appointed religion is the federal reserve. Mandatory service is twice daily consisting of sermons on the necessity of the latest bailout followed by the virtues of inflation rates and cost money to attend which isn't worth anything anymore.

There's an endless war going on somewhere, against someone, for some reason, it's all classified, but you're told it's so critical funding it takes priority over domestic utilities and public security.

You're forced to buy healthcare that you can't afford, also fund with taxes, and still won't cover anything anyway.

You subsidize cultivating food engineered to be it's own pesticide that's so cheap to make they'll actually pay you to eat it.

Mexico built a wall.

You know nobody anywhere on either side voted for any of this but if your toaster or refrigerator hear you say so your credit card stops working.

Everyone you know has cancer.



Do you accept the fate placed before you? Chosen by despots who arrest and savage anyone who would expose their high level corruption? Do you march in silence obediently into the end?

Or do you stand up, harness what's left of your human dignity, take back the reins of destiny, ...and kill Chris Cuomo?

WARNING! JOKE! THIS IS A JOKE! WARNING! JOKE! JOKE ABOVE!

JOKE ALERT! THIS IS A JOKE! DON'T KILL CHRIS CUOMO! JOKE ALERT! JOKE!



CIA FINDERS: IN THEIR OWN WORDS

The Customs representative stated that (6) children had been located in Florida along with two men and that the children were dirty, unkept, insect bitten, underfed and possibly sexually abused. U.S. Customs stated that they had tried to contact representatives of the Finders at [redacted] without success and they feared that other children were being abused at that address and were unsure if the children had been kidnapped from their parents. Detective [redacted] was put in contact with Investigator [redacted] and [redacted] of the Tallahassee Police who were the lead investigators in the case. [redacted] told [redacted] that the children were recovered in Tallahassee Florida after a call to police stating that six children were being kept in the back of a van near a Florida park. The police responded to that location and determined that the children were in fact in poor condition and tried to question the two men, identified as [redacted]. [redacted] refused to answer questions by the police and were arrested for child neglect. The children when interviewed by the Tallahassee Police stated that they were enroute to a "smart school" in Mexico and could not give any positive information concerning their parents. [redacted] stated that the children were all extremely hungry and urinated and defecated on the floor during the interviews. [redacted] stated that the children also talked about other children in Washington D.C. and stated that they were under the control of the "game caller", [redacted].

b6
b7C

This investigator was also advised by [redacted] of HRS that two children were confirmed cases of sexual abuse. She stated that the exams on [redacted] and [redacted] were consistent with sexual abuse, and that [redacted] had old bruises which were indicative of bite marks. [redacted] was not sure if the marks were adult or child bite marks.

b6
b7C

Following another group of interviews in an unrelated case, this investigator went

A SMALL MICRO-COMPUTER, TRS-80, WAS TAKEN FROM THE VAN BY FBI AUTHORITIES IN A SUBSEQUENT CHECK OF THE VAN ON SUNDAY, FEB 8. THE COMPUTER WAS EXAMINED BY AGENTS [redacted] AND [redacted] AND FOUND TO CONTAIN ONE MESSAGE THAT WAS COPIED DOWN. A COPY OF THE MESSAGE WAS GIVEN TO TPD.

b6
b7C

ALSO ON SUNDAY, FEB. 8, A PART-TIME EMPLOYEE OF TPD, [redacted] ALSO AN F.S.U. STUDENT, BROUGHT ANOTHER TRS-80 COMPUTER TO TPD AND TURNED IT OVER TO THIS INVESTIGATOR. HE INDICATED THAT HE WAS IN FRONT OF THE F.S.U. LIBRARY AND FOUND IT AT AN OUTSIDE PHONE ON THURSDAY MORNING, FEB. 5. HE INDICATED THAT HE HAD LEARNED HOW TO WORK IT AND FOUND MESSAGES IN IT THAT HAD NAMES OF TPD INVESTIGATORS AND OTHERS. HE THOUGHT IT MIGHT HAVE SOMETHING TO DO WITH THIS CASE AND THEREFORE BROUGHT IT TO TPD.

b6
b7C

THIS INVESTIGATOR EXAMINED THE COMPUTER AND TRANSCRIBED SEVERAL PAGES OF MESSAGES FROM IT. THE MESSAGES INDICATED THAT THEY WERE

CONTINUED ADDITIONAL INFORMATION:

BEING SENT VIA PHONE LINES TO A CENTRAL COMPUTER SYSTEM WHERE MEMBERS OF THE SAME GROUP CAN EXCHANGE MESSAGES. A MESSAGE TAKEN FROM THIS COMPUTER INDICATES THAT THEY WERE CONFUSED WHY THE MEN WITH THE KIDS HADN'T LEFT ANY MESSAGES. ANOTHER MESSAGE INDICATED THAT TWO MEN HAD BEEN ARRESTED IN TALLAHASSEE AND THE CHILDREN WERE BEING HELD. IT WAS LATER LEARNED THAT THIS COMPUTER WAS INADVERTANTLY LEFT AT THE F.S.U. PHONE BY MEMBERS OF THIS SAME GROUP BUT TRAVELING SEPARATELY.

INFORMATION OBTAINED FROM THE VAN ALSO WAS CONFUSING. SUSPECT

[REDACTED] HAD TWO MIRANDA RIGHTS FORMS THAT APPEARED TO BE SIMILAR. ONE

b6
b7C

INDICATED HIS NAME WAS [REDACTED] AND THE OTHER [REDACTED] BOTH FORMS

WERE INDICATING HIS RIGHT TO REMAIN SILENT, ETC. ONE OF THE FORMS

BEGAN, "I HAVE SOMETHING TO HIDE...." THE OTHER FORM BEGAN, "I HAVE

NOTHING TO HIDE..."

Search Warrants:

Based on the information received from the source and from the authorities in the State of Florida, AUSA [REDACTED] authorized a search warrant for the premises of [REDACTED] Washington D.C. Search Warrants were executed for the premises of [REDACTED] by members of the M.P.D Intelligence Division on February 5-6, 1987. Although no children were found large amounts of documents dealing with child rearing and shaping were recovered along with manuals for master plans and "dirty tricks" for enemies of the Finders group. All this information was turned over to the Florida authorities for evaluation.

b6
b7C

Medical Reports:

[REDACTED]

b3
b6
b7C

Psychological Report:

[REDACTED]

b3
b6
b7C

Interviews:

Detective [REDACTED] of the M.P.D. a expert profiler with extensive training with abused children interviewed both [REDACTED] in Tallahassee Florida during

041387-06 P. J. A.

~~OFFICIAL USE ONLY~~

PAGE 2 OF 4 PAGES

This report is the property of the Morals Division, Metropolitan Police Department, Washington, D.C.. Neither it nor its contents may be disseminated to any agency to which loaned.

~~SECRET~~

[Handwritten signature]

DOJ REVIEW OF USCS DOCUMENTS INDICATES THAT DURING THE EXECUTION OF THE SEARCH WARRANTS BY THE MPD AT THE TWO "FINDERS" PROPERTIES, USCS SA [REDACTED] CLAIMS TO HAVE OBSERVED A SUBSTANTIAL AMOUNT OF COMPUTER EQUIPMENT AND DOCUMENTS PURPORTEDLY CONTAINING INSTRUCTIONS FOR OBTAINING CHILDREN FOR UNSPECIFIED PURPOSES. THE INSTRUCTIONS ALLEGEDLY INCLUDED THE IMPREGNATION OF FEMALE MEMBERS OF THE COMMUNITY, PURCHASING CHILDREN, TRADING CHILDREN AND KIDNAPING THEM. [REDACTED] CLAIMS

b6
b7C
b7E

[REDACTED]

SYNOPSIS:

This report deals with the entire investigation concerning a group of subjects who call themselves The Finders. This document will explain the involvement of the Metropolitan Police Department and various agencies involved and the action taken during the course of this instant investigation. All the following information is still of a sensitive nature and should not be disseminated outside this unit.

Source Information:

In December of 1986, [redacted] called the intelligence division and reported that she had information concerning a cult operating in the District of Columbia. [redacted] was advised that Detective [redacted] of this office handled cult investigations and was currently out of town but would contact her after his return. [redacted] was contacted in late December by Detective [redacted] by telephone and [redacted] advised she wished to be interviewed concerning this cult. Detective [redacted] and Detective [redacted] of the Maryland Park Police (Because [redacted] stated a section of this cult was operating in Maryland) interviewed [redacted] at her residence in [redacted]. [redacted] stated that a group of individuals were trying to introduce her into a cult and explained the nature and circumstances of this cult. (SEE R.O.I. dated 12/18/86) [redacted] was advised that although this group was unusual, they were committing no criminal offenses and the police department would only be interested if this group was involved in criminal activities. In January 1987 [redacted] again contacted Detective [redacted] and stated that some of the members were interested in exploring satanism. Detective [redacted] again advised [redacted] that although satanist are not criminals, Detective [redacted] was interested in ascertaining what activity this group was involved in and asked [redacted] to call Detective [redacted] if additional information became available.

b6
b7C
b7D

Law Enforcement Information:

On February 5, 1987 Detective [redacted] received a phone call from the U.S. Customs Service in Tallahassee, Florida. Customs was trying to find out if the Intelligence Division had any information concerning a group of subjects known as The Finders.

b6

PRIOR TO 2/5/87, MPD [redacted] HAD

RECEIVED INFORMATION FROM A CONFIDENTIAL SOURCE, THAT A GROUP OF PEOPLE CALLING THEMSELVES, THE "FINDERS", WERE CONDUCTING BRAINWASHING TECHNIQUES AT [redacted]

b6
b7C
b7D

[redacted] THE SOURCE REPORTED

12:02 p.m. - [redacted]

[redacted] stated that she knows [redacted] that he is or was a farm hand on her neighbors farm. [redacted] stated that the farm belongs to the [redacted] and is used for watermelon growing. [redacted] stated that at the beginning of last week (Jan. 26-30) she saw [redacted] walk up and down her street with ten children. [redacted] stated that the children were living in the watermelon field belonging to [redacted] stated that all of the children were white and young. She thought it strange that the children were not in school since she was seeing them during the middle of the day. [redacted] stated that the children and [redacted] were in a van but she does not remember any details about the van.

b6
b7C

12:14 p.m. - [redacted]

Research Institute, Washington, D.C., [redacted]

Search warrants were prepared by the United States Attorney's Office, District of Columbia, for both the warehouse and residence. A USCSA participated in the execution of the search warrant at the 3918/3920 W Street address, where he claims to have seen the following:

[REDACTED]

b6

- Search warrants obtained by MPD Intel. Warehouse site of previous MPD Intel inquiry involving classified maps of underground tunnel/sewer system, Washington, DC.

A JOINT INVESTIGATION, CONDUCTED BY THE MPD AND WMFO, LEAD TO THE IDENTIFICATION AND INTERVIEW OF THE MOTHERS OF THE SIX CHILDREN, TWO OF THE FATHERS, AND SEVERAL OTHER KEY MEMBERS OF THE "FINDERS" GROUP. ON 2/18/87, WMFO PRESENTED THE RESULTS OF THEIR INVESTIGATION TO ASSISTANT UNITED STATES ATTORNEY [REDACTED]

b6
b7C

[REDACTED] UNITED STATES ATTORNEY'S OFFICE FOR THE DISTRICT OF [REDACTED]

CONTINUED ADDITIONAL INFORMATION:

WHEN THIS INVESTIGATOR ASKED THE MOTHERS WHY THE TWO SUSPECTS HAD INDICATED THAT THEY WERE TAKING THE CHILDREN TO MEXICO TO A SCHOOL FOR BRILLIANT CHILDREN THE MOTHERS INDICATED THAT THEY HAD TALKED ABOUT TAKING THE CHILDREN THERE POSSIBLY ONE DAY. NONE OF THE MOTHERS SEEM TO KNOW THAT A MESSAGE TOLD THE MEN TO USE THAT STORY IF STOPPED BY THE AUTHORITIES. THE MOTHERS SEEM TO AGREE THAT IT WAS POOR FOR THE MEN TO HAVE MADE THAT STATEMENT. IT WASN'T APPROPRIATE. THEY FURTHER CONCEDED THAT THE TWO MEN, [REDACTED] WEREN'T ARTICULATE AND HANDLED THE CONFRONTATION WITH THE PATROL OFFICERS POORLY. EACH MOTHER INDICATED THAT IT WAS UNDERSTANDABLE WHY THE OFFICERS WERE ASKING QUESTIONS AND HOW THE TWO MEN'S ACTIONS AND ANSWERS WOULD BE SUSPICIOUS." EACH MOTHER MAINTAINED THAT THERE IS NOTHING PARTICULAR THAT THEY ARE HIDING.

b6
b7C

THE PICTURES OF THE CHILDREN WITH SLAUGHTERED GOATS WAS NOT A RITUAL SACRIFICE BUT RATHER AN ATTEMPT AT A "HANDS ON" EXPERIENCE. ONE MOTHER, WHO WASN'T SURE THAT THE ORDEAL WAS NECESSARY OR THAT SHE APPROVED (SHE INDICATED THAT ONLY THE THREE MEN WERE PRESENT AT THE TIME) THOUGHT THAT THE EXPERIENCE WAS WELL INTENTIONED AS A EXPERIENCE FOR THE CHILDREN TO LEARN. SHE LIKENED THE SLAUGHTER TO THAT OF WHAT IS DONE IN CONVENTIONAL BIOLOGY CLASSES. SEVERAL MOTHERS INDICATED THAT THE "ROBES" BEING WORN BY THE MEN WERE ACTUALLY SHEETS THE MEN WORE DURING THE SLAUGHTER TO PROTECT THEIR CLOTHING. THE SLAUGHTER OF

the week of February 11, 1987. Detective [redacted] report is attached and made part of this summary.

Interviews:

Twenty one former Finders have been interviewed concerning thier involvement in the organization. They stated that the organization began as an alternative life style in the 1960's and many of them became disenchanted with the quasi-military order under the direct supervision of [redacted] Many of the former members stated that they feared retribution from the Finders organization. In the case of [redacted] she needed police intervention to stop the harrassment of the Finders, In the [redacted] case, [redacted] was burned down and remains a open arson. In the [redacted] case, members of the Finders attempted to infiltrate [redacted] in the United States. In general all members of the Finders who had left the group felt that harm would come to them if they spoke out against [redacted] or his organization.

b6
b7C

Family Members:

Detective [redacted] interviewed all the family members who were willing to talk. Specifically, they all stated that [redacted] had brainwashed thier children and prevented any contact with either thier children or grandchildren. Members of the Finders, according to family members would stop any contact by sending letters describing explicit sexual acts involving current members, including photographs and drawings. In the [redacted] case members of the Finders attempted to take over the [redacted] family residence and force [redacted] out of her home.

b6
b7C

Virginia State Investigation:

Special Agent [redacted] of the Virginia State Police stated that his organization executed search warrants at the Finders Farm in Madison County Virginia. [redacted] stated that this group appeared to be a survivalist organization with attempts to take over the city government in Culpepper Virginia. During Virginia States investigation information was revealed that bodies were buried on the farm at the Nethers, but excavation revealed nothing. However, cages were discovered on the premises that witnesses revealed were used to keep children during thier visits to the farm.

b6
b7C

F.B.I. Investigation:

The F.B.I. had contact with the Finders since 1971 including a recent report dealing with C.I.A. involvement with at least one of the members of the Finders passing information overseas concerning activities of the Central Intelligence Agency. When it became apparent that no Federal Laws were violated the F.B.I. vacated the investigation.

NOV-24-1993 16:06 FROM FBI UCMS ~~SECRET~~ TO P.05

DRAFT

(CIA) concerning any contact that members of the Finders may have had with the CIA. [redacted] confirmed that [redacted] Isabelle (deceased at the time of the report), was a CIA employee from 1950 until 1971. [redacted] had asked S/A [redacted] "...if our investigation was treading on anyone's toes out there..." [redacted] had replied "Sort of...He acknowledged that they have had someone working on the case since it first broke on the news media.. [redacted]

b1 per CIA
b3
b6
b7C

[redacted] Future Enterprises operates out of the warehouse at 1307 4th St NE..." S/A [redacted] had indicated that the CIA had been aware that during the period 1969-1971, [redacted] had traveled to Moscow, North Korea and North Vietnam.

b1 per CIA
b3
b6
b7C

This report stated that the CIA "apparently has a vested interest in [redacted] and/or the group. They have not contacted any of the investigating agencies while they have been working on the case...In summary, [redacted]

(S)
(S)

[redacted] there will be no justification for the way the children have been treated, and the matter will be addressed in Family Division, Superior Court."

The report was marked "CONFIDENTIAL" and "DO NOT DISSEMINATE," and was signed by MPD Sergeant (Sgt.) J.H. Sticher. It is noted that throughout this report, the name [redacted] had been lined out, and the name [redacted] had been penciled in above the lined out name.

b3 per CIA
b6
b7C

- [redacted]
- [redacted] contacts MPD Intelligence and advised that all reports regarding Finders are to be classified at the Secret level. [redacted] also advised that no information was to be turned over to the FBI WFO for investigation, and that the WFO would not be advised of the [redacted] involvement/contact. b7E
- Children discovered in Tallahassee were eventually turned over to individuals claiming to be parents or guardians. No further MPD, FBI or Customs involvement.
- As far as is known, no details of [redacted] involvement ever became public.

- Search warrants executed with MPD and two U.S. Customs agents (one at each site). FBI not involved until walk through on following day.
- Seizure of numerous documents made to include passports, telexes, computer/electronic media, correspondence, et al. (See previous material for expanded description).
- After search warrant shut down on first day, news reports carried FBI press release announcing FBI as "lead investigating agench." Day after, once search resumed, FBI agent from Washington Field Office (WFO) makes walk through of warehouse, but does not examine any seized evidence.
- Additional search warrant executed on farm in rural Virginia with support by Virginia State Police. No federal involvement. Evidence of satanic/cult ritual discovered.
- Based on observed documents, Customs agent unsuccessfully attempts to gain access to evidence for detailed analysis for use in investigating possible export, neutrality act, mann act, and child pornography violations.

- [redacted]

b6
b7C

THE "FINDERS" INVESTIGATION AND TO DATE HAS BEEN UNABLE TO LOCATE ANYONE WITH KNOWLEDGE OF THE DOCUMENTS [redacted] CLAIMS TO HAVE SEEN OR, EVIDENCE OF ANY OUTSIDE INQUIRIES/ INTERFERENCE IN THE CONDUCT OF THE 1987 FINDERS INVESTIGATION.

THE WMFO INVESTIGATION DID REVEAL THAT [redacted] WAS CONFRONTED BY THE WMFO CASE AGENT ON 2/19/87, CONCERNING THE ITEMS HE CLAIMED TO HAVE SEEN. [redacted] CONTENDED THAT HE BELIEVED HE DID SEE THE ITEMS, AND STATED THAT HE WOULD CONTACT MPD CONCERNING THEM. THE WMFO CASE AGENT CONTACTED THE MPD DETECTIVE ASSIGNED THE CASE, WHO ADVISED THAT NONE OF THE ITEMS MENTIONED BY [redacted] EXISTED IN THE ITEMS SEIZED BY MPD. THE DETECTIVE RELATED THAT [redacted] WAS WITH HIM AT THE SEARCH SITES, AND IT WAS NOT POSSIBLE THAT SUCH ITEMS WERE MISSED. THE DETECTIVE ALSO ADVISED THAT [redacted] HAD NOT CONTACTED MPD IN AN ATTEMPT TO VIEW THE SEIZED ITEMS.

b6
b7C

[redacted] WAS INTERVIEWED BY WMFO ON 12/20/93 AT USCS HEADQUARTERS. [redacted]

[redacted]

The WRATH OF GOD FORMULA ①



WINE

50%

BLOOD

50%

ROTATE ON WINE
MACHINE FOR 24 HOURS

TO RECEIVE BLOOD YOU
MUST DO A PHLYBOTOMY
PROCEDURE ON A BEAUTIFUL
SPIRITUAL PERSON AND
DRAW BLOOD, FIRST CHECK
FOR TRANSMITTED DISEASES
IT MUST COME BACK
NEGATIVE OF NO TRANS-
MITTED DISEASES. THEN
COLLECT BAG OF BLOOD
AND MIX WITH EXPENSIVE
WINE AND ROTATE FOR
24 HOURS.

IT CURES CANCER 2.
IT CURES DISEASES
IT GIVES GREAT BEAUTY
IT GIVES GREAT STRENGTH
IT GIVES ETERNAL LIFE
IT CURES POSSESSED.

FREE INFORMATION
NO ASK FOR NOTHING
I AM A COLLEGE EDUCATED
MEDICAL ASSISTANT
PHYSIOLOGY ASSISTANT

MAJOR GENERAL BIOLOGY
IN HIGH SCHOOL.



YOU LIVE IN A CITY? NO? TURN TO PAGE 138

YOU LIVE IN A CITY? YES? YOU WAKE UP ON AN ELONGATED BOX

BOX LIFE



THAT BOX IS IN ANOTHER BOX - YOUR BEDROOM

THAT BOX IS IN ANOTHER BOX - YOUR APARTMENT. IT'S A SERIES OF BOXES IN ANOTHER BOX - YOUR BUILDING

WALK THE BLOCKS IN SHAPES OF BOXES TO THE TRAIN, WHERE YOU GET ON ANOTHER BOX ON WHEELS THROUGH A TUNNEL AND DON'T YOU FUCKING SAY A WORD TO ANYONE, JUST THE WAY YOU AVOID EYE CONTACT WITH YOUR NEIGHBORS

HURRY TO YOUR BOX IN THE BOX FARM WHERE YOU WORK ON SMALLER BOXES IN A SHEET OF BOXES. WHAT SPREAD? THERE IS NO SPREAD! ONLY BOXES ON THIS SHEET HAHAAAA



**PUT THE PLASTIC BOX WITH A SCREEN,
BATTERY AND YOUR GPS LOCATION YOU
MOLEST WITH YOUR THUMBS AWAY**

**IF YOU'RE LUCKY YOU'LL SPEND MORE
TIME WITH THESE STRANGERS IN THIS
SKINNER BOX CAREER SUBSTITUTE THAN
YOUR FAMILY IS IT BECAUSE THERE ARE
NO COSTS IN LIFE, ONLY TRADE OFFS?**

**NO. THERE IS ONLY THE GRINDING MISERY
AND FUNERALS FOR THINGS THAT COULDVE
BEEN. IT IS BY DESIGN BECAUSE I WOULDNT
WANT TO LIVE IN A WORLD WHERE EVERY
BOY BECOMES A TRUCK DRIVING
FIREFIGHTER MICROBIOLOGIST MORTAR
FODDER
PLACEHOLDER AND EVERY GIRL BECOMES
A HALF-NAKED TWITCH STREAMER
BALLERINA MINOR TWITTER CELEBRITY**

**TIME FOR WATER OR PISS AND MOVING
YOUR LEGS TO KEEP THE HEADACHES THAT
COME WITHIN FROM INTERFERING WITH
THE EXTERNAL-SOURCED MIGRAINE OF
POST MODERN LIFE. MAYBE IDLE IN THE
PISS AND SHIT BOX WITH STALLS AND A
DOOR FOR PRIVACY BEFORE RESIGNING
YOURSELF TO THIS FIVE DAY CYCLE OF JOY**

**KEEP IT UP, YOU'LL COME TO DESPISE YOUR
IDEAS BEFORE YOU SLOWLY DO AWAY WITH
YOUR DIGNITY AND RESPECT. DONT LOSE
SIGHT OF THE BOXES, YOU'LL RETURN
HOME TO STARE AT A GLOWING ONE AFTER
YELLING AT THE SMALLER ONE SINCE THIS
MORNING.**

**SETTLE FOR WHAT YOU'RE TOLD TO EXPECT,
DONT TAKE CHANCES. THE ROAD LESS
TRAVELED IS LESS TRAVELED FOR A REASON,
AND NOT ENOUGH BOXES FOR YOUR
REFINED AND EFFICIENT BUT LOVELESS
TASTES. IS TASTE SOMETHING MORE THAN
WHAT HAPPENS AFTER YOU TAKE A PICTURE
OF WHAT YOU'RE EATING?**

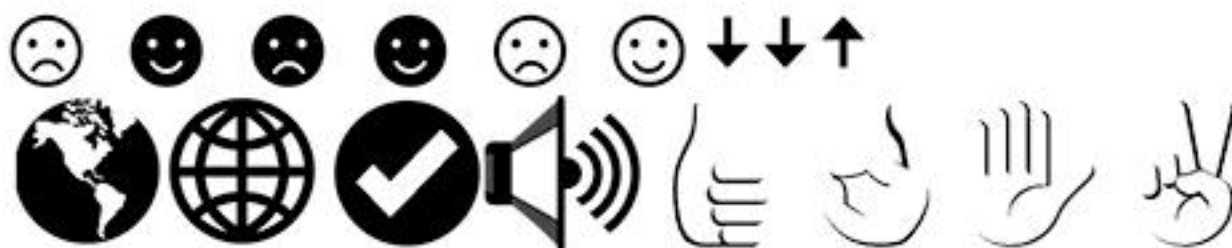

**CHASE USELESS TOYS AND GADGETS FOR
THE PERFECT BABY SITTER, OR CLAIM THAT
YOU VALUE EXPERIENCES OVER THINGS
EVEN THOUGH THOSE EXPERIENCES ARE
ONLY IMPORTANT IF OTHERS KNOW ABOUT
IT AND SCROLL PAST THEM THEM AND ALL
THE MEANINGFUL MOMENTS OF YOUR LIFE
IN A THREE BY THREE GRID THROUGH A
DINKY LENS AND GAUDY FILTER.**

**THE HYPOTHERMIA OF YOUR SPIRIT IS
PERFECTLY NORMAL IF YOU'RE BORN ON
THE CUTTING ROOM FLOOR LIKE THE REST
OF US. JUST LOOK AT ALL THIS PROGRESS,
ALL THESE BOXES. WE ALL MUST YIELD TO
THE ULTIMATE BOX - YOUR CALENDAR.**

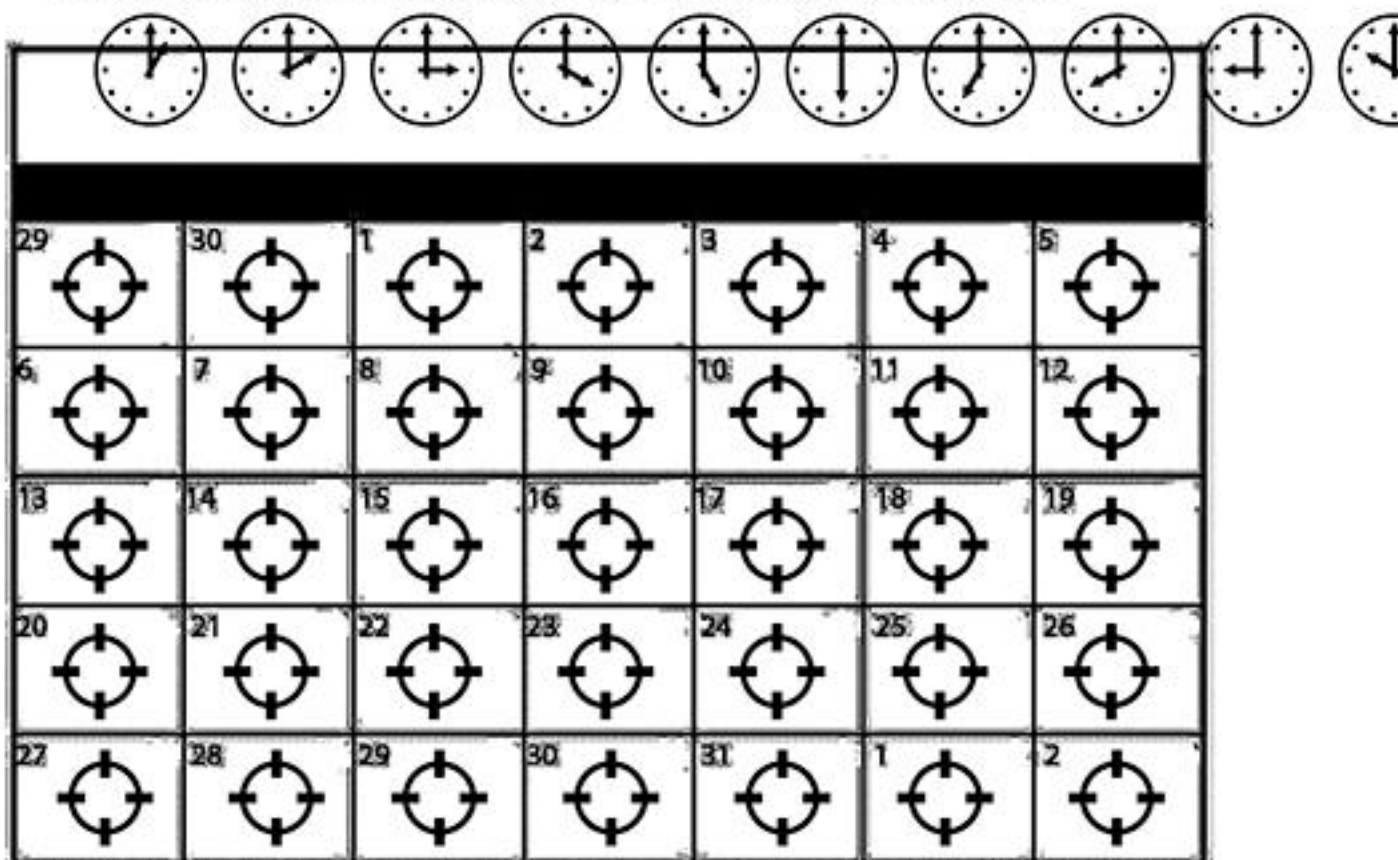

**TWELVE PAGES OF BOXES, THERE IS NO
ESCAPE. ITS WHY YOU'RE AFRAID TO
RESPECT YOURSELF. IT LEADS YOU DOWN
GARDEN PATH AFTER PATH WITH CARROTS
ON A STICK. IT WILL LET YOU TASTE BUT
NEVER EMBRACE. PEEK IN THE WRONG
DOOR, IT SLAMS IT ON YOUR FINGERS. GO
BACK! ADVENTURE IS NOT ALLOWED! GO
BACK - NOT ALLOWED! IT WILL
LEAVE YOU EXHAUSTED, HENPECKED AND
AFRAID.**

**NEVER QUITE ENOUGH MONEY, NEVER
QUITE ENOUGH NERVE TO REACH OUT FOR
SOMETHING BETTER THAN THE GRIND YOU
CALL YOUR LIFE.**

**PRAISE BE UNTO THE BOX LIFE,
THERE IS NO OTHER WAY**

ARE YOU A SUPERPREDATOR???

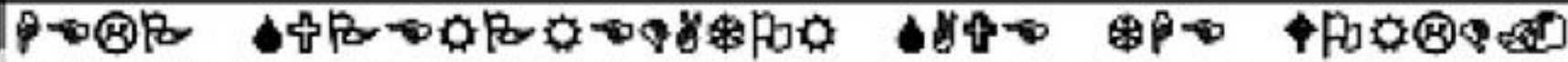

**ATTENTION ALL FREE THINKERS, NEO-SCHIZOS, AND CYPERPROPHETS!!!
ATTENTION ALIENATED DISSIDENTS, CULTURAL OUTSIDERS, BLACK PEOPLE
AND TARGETED INDIVIDUALS OF ALL TYPE AND KIND!!!**

Are you depressed or worried by the state of public consciousness and discourse? Do you feel frustrated by the THING stifling our resources for info and communication? ARE you shunned by all sides of popular politics for not blowing the party line? Wanna talk about it?

IF SO THAN SUPERPEDATOR WAS MADE FOR YOU!!!

SUPERPREDATOR IS NOT:

A high-tech deep-state psy-op financed by the people, for the people, to undermine the better interest of all human kind!

Affiliated with or advocate of any/all political parties, corporate or state organizations, or philisophical ideologies, real or imaginary!

A proponent of hatred towards or violence, ever, against any/all individuals or groups of human beings anywhere, real or imaginary!

In absolutely any way, at any time, under any circumstances, advocating for anything that YOU PERSONALLY don't agree with!

SUPERPREDATOR IS:

The only good thing to come out of politics!

A free and public domain initiative to broaden the shrinking avenues of fre speech and ideas excluded by the corporate hellword agenda!

Outsider media that realizes everybody everywhere has become an outsider!

Smarter and deeper and more important than it acutally is!

The only news outlet on earth fortified for this mad new world, and MANKIND'S ONLY HOPE FOR A FUTURE!!!

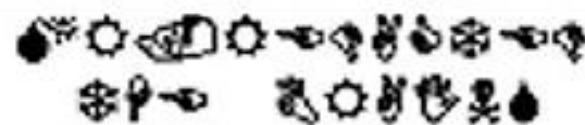
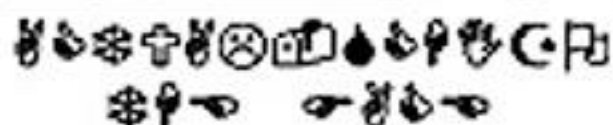

IF YOU

Are alarmed by disinfo and propaganda being so abundant that observing it seems mundane,

IF YOU

Would rather people argue about TRILLIONS of TAX\$\$\$ slipping through the PENTAGON's books EVERY YEAR & FASAB56 rendering those stolen funds STATE SECRETS, instead of arguing about RED-PEDO vs BLUE-PEDO POISON EARTHHELLWORLD IRRELEVANCE,

THAN YOU HAVE THE POWER TO MAKE THE TRUTH INESCAPABLE!

Write truth on the wall! Post truth at bus stops! Nobody owns the truth! Truth belongs to you!

NOBODY ASKS PERMISSION TO BECOME A SUPERPREDATOR!!!

Write it down and print it out! Add what you like! Copied, cut, revised, & written by free citizens! Each modified copy more true than the last!! Add truth you know and know needs to be known!

IT ONLY MAKES IT MORE TRUE!!!

Ever seen a cloud floating BEHIND the moon?

Find a way to evade or deactivate the cameras hidden in the eyes of postmen and dollar bills?

Think that the USA's political system is a sham?

**IT'S TOO LATE TO SEEK HELP!
YOU ARE A SUPERPREDATOR!!!**



READ AND DOWNLOAD DIGITAL COPIES!
MAIL ORDER OFFICIAL PRINT ISSUES!
CONTRIBUTE WORKS FOR PUBLICATION!
AT THE OFFICIAL INTERNET WEBZONE:

<https://SUPERPREDATOR.zone>

STRIKE BACK AT YOUR FUTURE SELF
AND THE THING BEHIND THE CURTAIN!

**JOIN THE FIGHT AGAINST
MASS PSYCHOSIS TODAY.**



MANIFEST THE TRUTH WITHIN THE REAL



BECOME A SUPER PREDATOR!

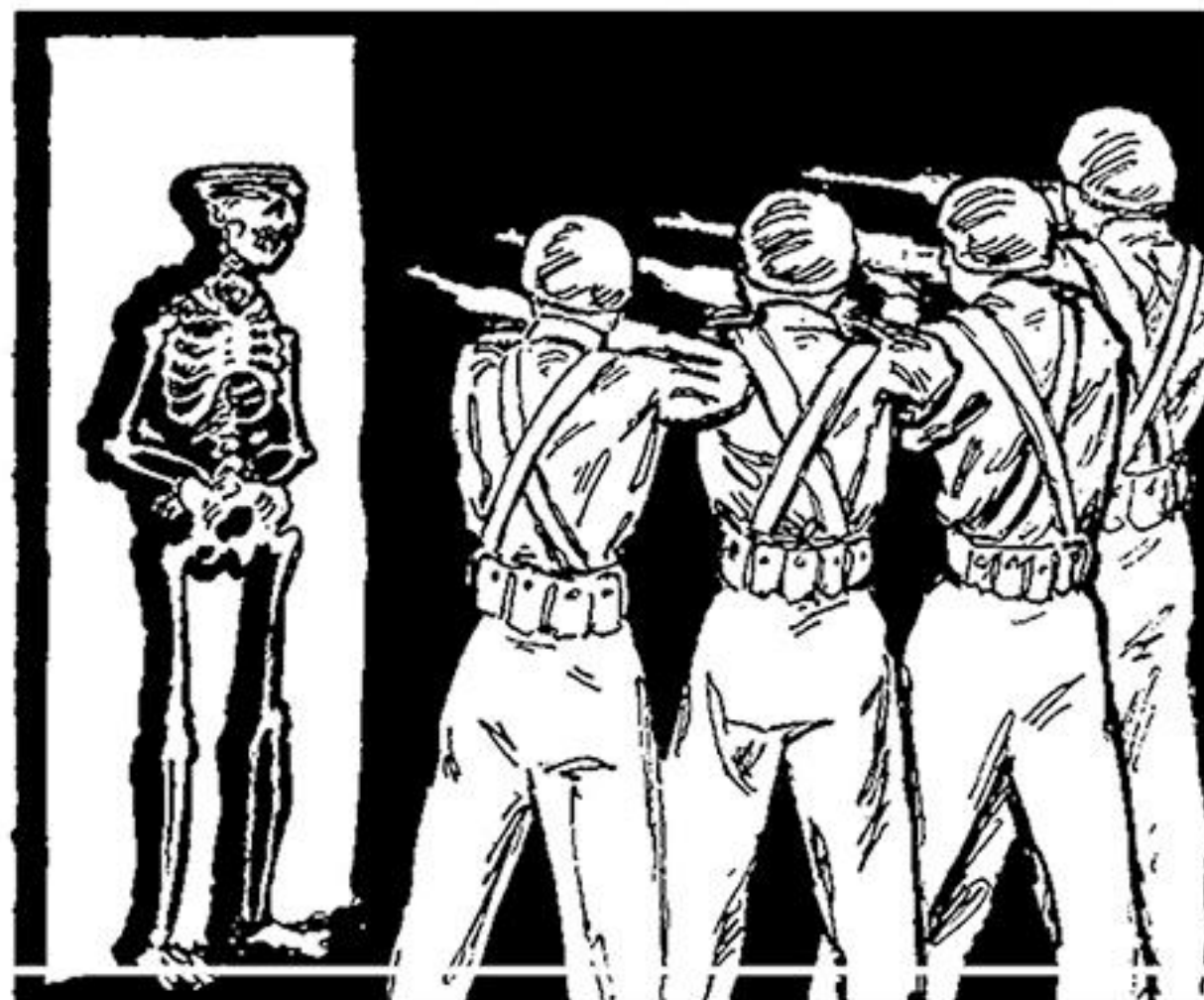



**THE DEAD GODS
ARE WAKING UP**



**YOU NEED TO BUILD
A BOMB SHELTER**

